



# Remote Electrical Tilt System

Overview of Products, Installation,  
Control Possibilities and FAQs



MOBILE  
COMMUNICATION

**KATHREIN**

# KATHREIN

## Who we are and what we stand for

**Kathrein is a specialist for reliable, high-quality communication technologies.**

The company is driving innovation and technology in today's connected world. Its ability to provide solutions and services enables people all over the world to communicate, access information and use media, whether at home, at the office or on the road.

The business covers a broad spectrum: from mobile communication, RFID and special solutions, to satellite reception and broadcast technology, to transmission and reception systems in vehicles.

As a hidden champion and family-owned enterprise, Kathrein has been working on the technologies of tomorrow since 1919. The company takes pride in its dedicated employees and passion for customers and quality.

### Our Solutions

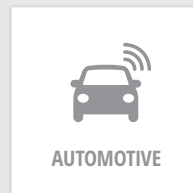
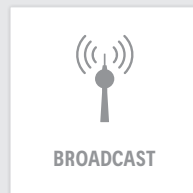
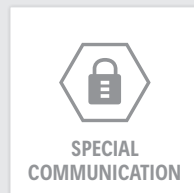
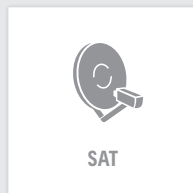
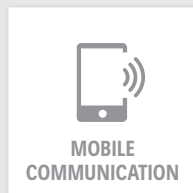

Find out more about us at [www.kathrein.com](http://www.kathrein.com)



## Remote Electrical Tilt System

Time is money, and setting up a mobile site takes time. So why not cut set-up time by using Kathrein's optimised products? Kathrein's RET products such as the FlexRET and RFID-RCU guarantee quick and easy set-up through automatic antenna configuration. As an added benefit, they minimise potential RET installation errors. Kathrein's RET control devices make initial configuration and targeted optimisation much easier. What's more, the Kathrein GPS Azimuth Adjustment Tool allows fast and precise azimuth adjustment of the antennas on site. In addition, the Kathrein Antenna Monitoring Unit allows precise surveying of site parameters during the operation.

## Introduction

### Why Not Make Life Easier with the FlexRET and RFID-RCU?

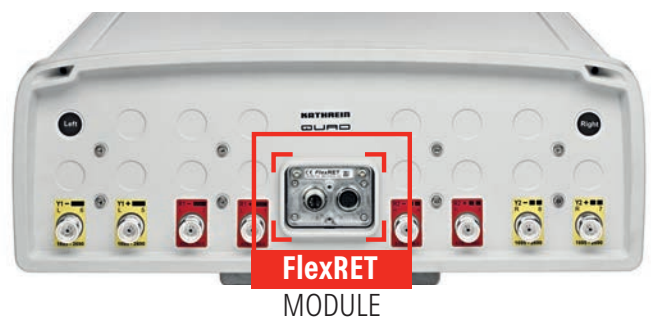

Modern mobile communication networks often provide the possibility of controlling the electrical downtilt of antennas remotely. As a result, most antennas need to be equipped with Remote Control Units (RCUs) in order to be able to change the downtilt without the need to physically access the sites.

Not only do these RCUs need to be installed, they also need to be configured in accordance with the connected antenna. This results in an additional amount of time spent on site and a possible source of human error.

In order to make the whole installation process easier, Kathrein offers two solutions to simplify remote electrical tilting of base station antennas: FlexRET antennas and an RCU with integrated RFID feature.

The control unit is integrated into the antenna radome for FlexRET antennas. This integrated module is pre-configured and calibrated ex-factory. That means all relevant antenna data is already stored in the FlexRET module and is automatically transferred to the used primary (e.g. Base Station (BTS) or Kathrein control device). As a result, this information does not need to be entered in manually during installation.

The FlexRET unit provides one AISG input and one output. Only one AISG cable is needed for control. Of course, FlexRET antennas can also be deployed in a daisy-chain configuration with further FlexRET antennas and/or external RCUs.

For site/antenna sharing purposes, a Gender Adapter (type no. 86010162) or a Site Sharing Adapter (type no. 86010154/55) can be used. With a Site Sharing Adapter, up to three respectively six different BTS or operators can flexibly be interconnected to one common FlexRET antenna. In case exactly two BTS shall be interconnected, the Gender Adapter can be used. If exactly two BTS are used and the allocated FlexRET antennas shall be used in daisy-chain configuration, a Port Extender (type no. 86010163) is needed. Further configuration details are given on pages 12–15.

#### ADVANTAGES OF FLEXRET ANTENNAS

- Only 1 x AISG in and 1 x AISG out (for daisy chain)
- Reduction of AISG cables
- No external RCUs need to be installed
- Site sharing possibility with the Site Sharing Adapter or the Gender Adapter/Port Extender

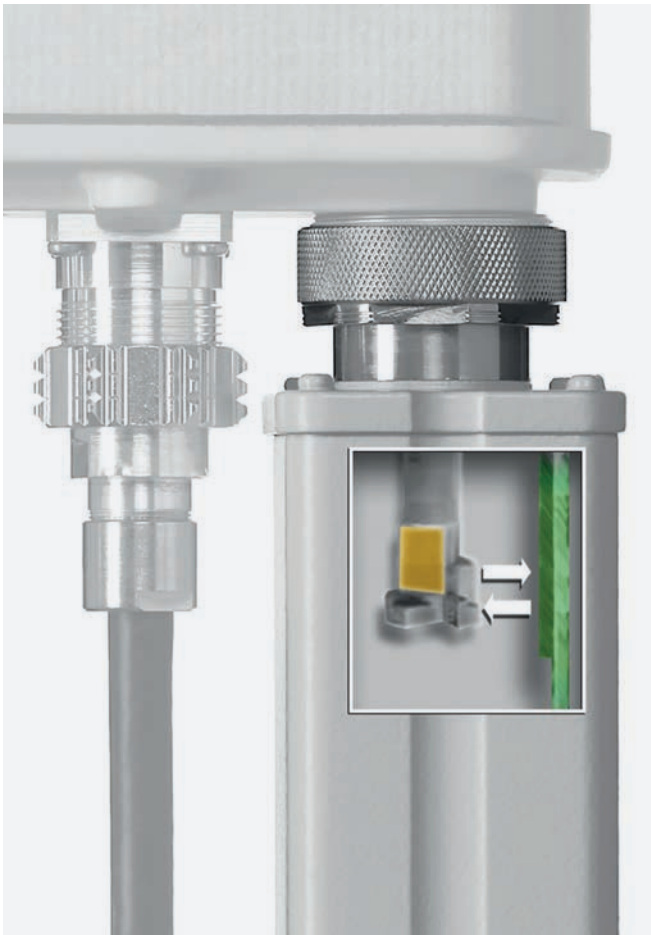

Furthermore, Kathrein also provides another innovative solution for all existing antennas with external RCUs: an RCU with RFID feature, thereby providing RFID-based communication between the antenna and the RCU.

This upgraded RCU is equipped with an RFID reader. In addition, our portfolio of antennas has been changed over to spindles with RFID tags.

All relevant antenna data is stored on this tag, namely the antenna configuration file, the antenna serial number and the antenna model number. After mounting the RCU to the antenna, all data stored on the antenna tag is read by the RCU once the power is switched on. Only specific site information needs to be added manually. The calibration is automatically performed when setting the first tilt value.

#### ADVANTAGES OF BOTH INNOVATIVE DEVICES

- No additional calibration and antenna type configuration on site necessary
- Only site-specific information needs to be added
- Possible configuration and installation errors can be avoided
- Saving installation time and costs
- Potential savings of Opex and Capex

All antennas with an RFID tag are clearly marked. One marking can be found on the antenna label showing the following symbol:



In addition, the packaging is marked with the same logo.

Both systems are compliant to AISG 2.0/3GPP (default setting) and AISG 1.1. An up-to-date list of all antennas with RFID spindle is provided on our website.

## RET Components

 <p><b>FlexRET Module</b>   86010153V01</p>	 <p><b>Gender Adapter</b>   86010162</p>	 <p><b>Port Extender</b>   86010163</p>
 <p><b>Remote Control Unit (RCU)</b> with RFID feature   86010148V01</p>	 <p><b>Torque screwdriver</b>   85010080</p>	 <p><b>Control cable</b>   86010007</p>
 <p><b>PCA (Portable Control Adapter)</b>   86010046</p>	 <p><b>Lightning protection device</b>   86010030</p>	 <p><b>Site Sharing Adapter (3-/6-way)</b>   86010154/-155</p>
 <p><b>DC Power and Signal Splitter</b>   86010002</p>	 <p><b>ALC (Antenna Line Configurator)</b>   86010156</p>	 <p><b>Earthing clamp</b>   86010031</p>

All data sheets can be found at [www.kathrein.com](http://www.kathrein.com)



Kathrein's overall RET system works in accordance with the AISG (Antenna Interface Standards Group) standard and 3GPP (3<sup>rd</sup> Generation Partnership Project).

### > OPTIONAL

 <p><b>Smart Bias Tee</b>   78211053ff or 78211590ff</p>	 <p><b>AISG-DTMA</b> (Double Tower Mounted Amplifier) ▶ <b>Pages 26-27</b></p>
---	---

## Kathrein's RET System

### > Already Used and Installed All Over the World



Multi-operator site at the Oktoberfest in Munich with Kathrein's RET system



Installation of 3 x 12-port Kathrein FlexRET antenna 80010899 with 6-way Site Sharing Adapter



Antenna site for LTE 800 and UMTS 2100 with two Kathrein 4-port antennas and RCUs for each system

## Control Devices

### > Antenna Line Configurator (ALC)

The Antenna Line Configurator (ALC) is a stand-alone device for the configuration and control of AISG antenna line products such as Kathrein's RET system. For operation, no external power supply and no PC or laptop are required. The ALC is designed for on-site use and has a touchscreen display which is sunlight visible. Its size is only 265 x 102 x 37 mm and it has an extra clip to securely fix it during the site access.

#### A variety of functions can be controlled with the ALC:

- Scan for AISG devices
- Select and configure the scanned devices (e.g. adjust the downtilt of the antenna)
- Documentation and protocolling of antenna installation parameters in a report file
- Update the software of the used antenna line devices such as RCUs, FlexRET antennas and DTMA's
- Check and store the mechanical downtilt of the antenna with the internal tilt sensor
- Direct configuration of the Site Sharing Adapter



Antenna Line Configurator

All complex functions and data which need more storage can be transferred via Wi-Fi to an arbitrary mobile device such as a tablet, smartphone or laptop. A USB connection between the ALC and a laptop is also possible. The mobile device does not need special software, a standard web browser is sufficient.

With one single ALC, up to nine RET devices, i.e. FlexRET antennas, external RCUs or a combination of both can be controlled, depending on the system configuration and the length of the control cable.



## > Portable Control Adapter (PCA)

The PCA is a portable controller for the on-site configuration of AISG antenna line devices, such as DTMA, RCU or FlexRET antennas. This product is designed for mobile applications to be used by installers or maintenance staff with temporary access to the antenna site. Mainly, the PCA is used for the configuration of AISG devices directly after the installation. The PCA consists of a small control box and Windows-based software to be installed on a laptop. The control box with dimensions of 40 x 95 x 160 mm (H x W x D) transforms the USB interface into an AISG-conform interface (RS 485 & DC voltage). Together with the supplied software, all functions of the connected devices can be controlled via a laptop. Up to 27 RET devices (external RCUs or FlexRET antennas) can be managed using one PCA.

The PCA can also be used to configure the Site Sharing Adapter. For this, special Site Sharing Configuration software is provided at [www.kathrein.com](http://www.kathrein.com) which needs to be executed on a laptop/computer. With this software, the antenna arrays can flexibly be allocated to the different BTS and the configuration can directly be set via the PCA.



Portable Control Adapter

## > Connection Possibilities for RET Control Devices

For the communication between the control devices and the RCU or FlexRET antenna, different options are possible, for example:

1. Using separate RCU control cables
2. Using two Smart Bias Tees (SBT) in the feeder lines
3. Via a DTMA at the antenna and a Smart Bias Tee at the base station

The picture on the right illustrates these options schematically.

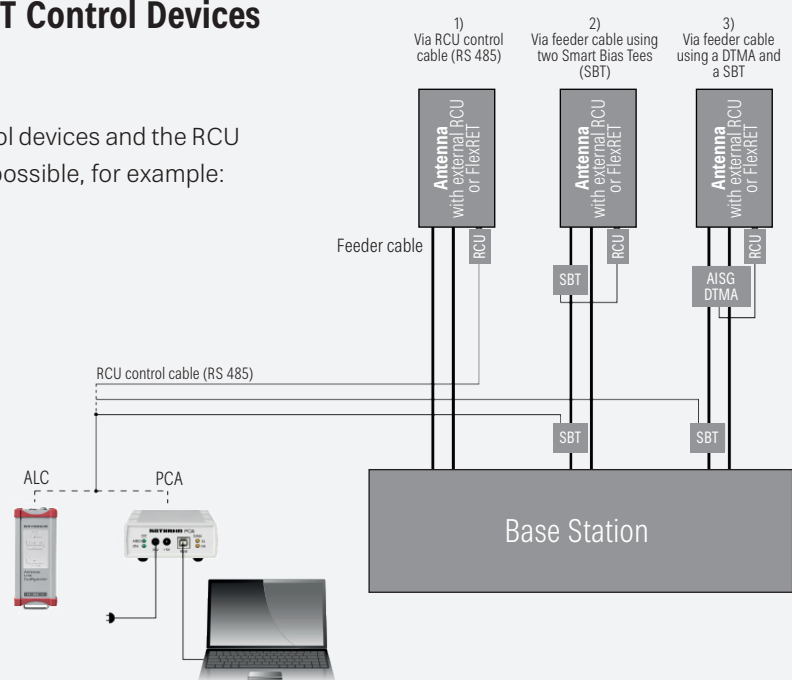

## Adjustment and Monitoring of the Antenna

The basis for the functionality of a mobile communication network is not only the quality of the used products but also the site planning. If the site planning is not correctly and accurately realised during the initial installation, this may result in poor network quality and a dissatisfied subscriber base.

Therefore, an accurate site installation can be seen as one of the essential issues in order to ensure the best possible subscriber or user experience. One critical parameter during the installation process is the azimuth adjustment of the antennas on site.

### > GPS Azimuth Adjustment Tool

In order to ensure the correct adjustment during the site installation, a precise adjustment tool is needed. In addition, the sites are often hard to access, so the efforts involved in the adjustment itself should be kept to a minimum. Kathrein's GPS Azimuth Adjustment Tool (type no. 86010157) offers a very accurate and easy-to-handle adjustment of the antenna's azimuth. It consists of a GPS-based measurement tool in combination with a tablet for the adjustment control and site documentation. The outdoor tablet provides a special app for the easy documentation of the site installation.



Start screen of the Kathrein app on the outdoor tablet

#### FEATURES

- **Measurable parameters:**
  - GPS position
  - Azimuth
  - Mechanical downtilt
  - Orthometric height
  - Roll
- Up to six hours operating time
- Compact size and limited weight
- Wireless communication between tool and tablet, no cabling necessary
- Suitable for all mobile panel antennas



The tool can be easily mounted to any panel antenna by using different adapter plates, a special mounting belt or the universal mounting support.



The tool is extendable for best signal reception

## > Antenna Monitoring Unit

Due to weather or atmospheric conditions, windstorm effects and further external influences, set mechanical parameters on antenna sites are prone to changes over time. In general, these parameters need to be controlled regularly in order to ensure the steady optimum network coverage.

To simplify this process, the Antenna Monitoring Unit (AMU, type no. 86010129) can be applied. The unit is mounted permanently on the upper side of the antenna to monitor site parameters such as:

- GPS position
- Azimuth
- Mechanical downtilt
- Orthometric height
- Roll

In order to ensure the smooth integration of the AMU into existing infrastructure, the communication is performed via AISG. The AMU, thereby, fulfils the following extensions to AISG v2:

- ASD (Alignment Sensor Device)
- GLS (Geographic Location Sensor)

In accordance with the AISG specification, the AMU can also be operated in daisy chain with further AISG devices such as RET devices and DTMA's. Therefore, the device provides an AISG input and output. In addition, the AMU can be operated as a RET device, whereby the measured parameters are reported in the additional device data fields according to AISG/3GPP.

Another feature is the transmission of the GPS clock signal for BTS time synchronisation. A direct connection can be established in between the base station and the AMU using the SMA connector. Thus, the timing information can be transmitted in real time.

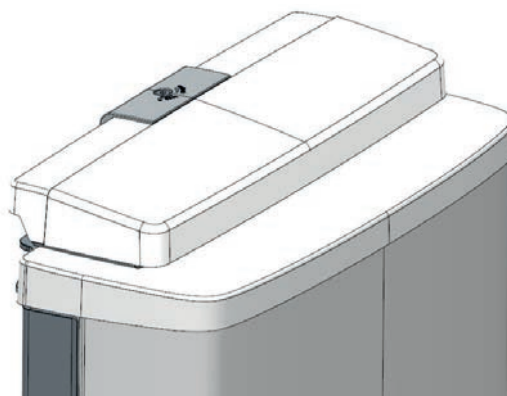

AMU mounted on an antenna

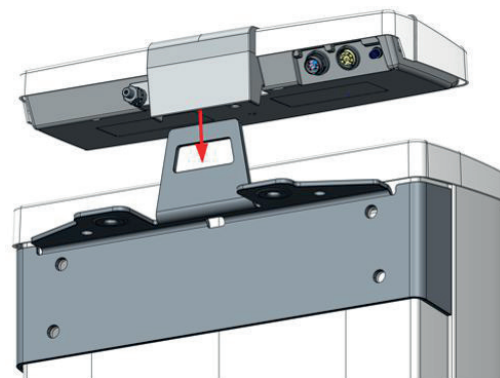

The AMU can be mounted directly on the crane hook (XH design); for other Kathrein panel antennas, the AMU is mounted using an additional adapter plate

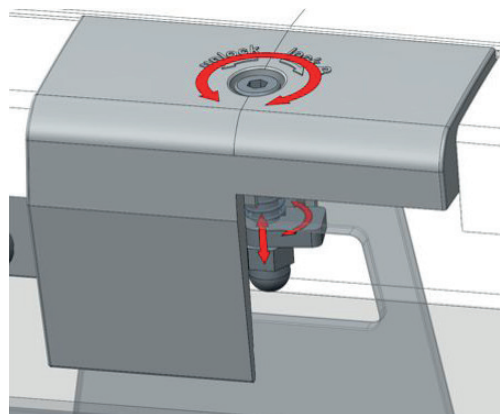

## Installation Guidelines – FlexRET Antennas

### > Single BTS Operation



For RET control of the FlexRET antenna via one base station (BTS), only one AISG cable needs to be connected to the AISG input of the FlexRET module of the antenna. To achieve this, remove the protection cap from the AISG input which is marked by the word “in”. The control cable needs to be fixed with a tightening torque of 0.5–1.0 Nm. This can be done by hand or by a special torque screwdriver (type no. 85010080).

After scanning the FlexRET device with the primary (i.e. BTS or an adequate control device, such as the Kathrein ALC or PCA), the following antenna information is automatically read out:

1. Antenna type number
2. Antenna serial number
3. Antenna configuration file

An initial calibration is not necessary since the FlexRET antennas are pre-configured and calibrated ex factory.

The serial number of the FlexRET module is extended by the AISG colour coding array ID of each array, e.g. by “Y1” for the first broadband highband array. Example: CSG3415804-**Y1**. In case the FlexRET module is manually addressed, the colour coding extension needs to be added to the serial number of the module like indicated.

#### RET Modes

According to 3GPP, the FlexRET antennas can be operated in SingleRET (default) and MultiRET mode which are switchable. The mode required is dependent on the mode operated by the BTS. Any queries related to the mode of operation of the base station should be directed to the corresponding BTS supplier. The set mode has no impact on the operation of the antenna but only on the communication between the primary and the FlexRET antenna.

### > Operation With Several BTS

If the RET control of a FlexRET antenna cannot be handled via one single RET-signal path, the different RET signals need to be interconnected to the FlexRET input of the antenna. For this, two different possibilities exist: if exactly two BTS need to be connected to the FlexRET antenna, a Gender Adapter (type no. 86010162) respectively a Port Extender (type no. 86010163) can be used. If more than two BTS are connected, a Site Sharing Adapter is needed (type no. 86010154/55). With these Site Sharing Adapters, up to three respectively six different BTS or operators can be connected to one common FlexRET antenna input.

#### PLEASE NOTE!

**A combination of the Gender Adapter/Port Extender and the Site Sharing Adapter is not possible.**

### Connecting Two BTS Using a Gender Adapter

The Gender Adapter converts the FlexRET output to a FlexRET input. If the Gender Adapter is used, the type number of the FlexRET module needs to be 86010153V01. The type number can be found on the outer label of the FlexRET module. If the type number version is lower, the FlexRET module needs to be exchanged beforehand, compare “Exchanging the FlexRET Module” on page 15. To operate the FlexRET antenna with the Gender Adapter, the adapter needs to be mounted on the FlexRET output (marked with “out”). For this, the chequered side of the Gender Adapter needs to be screwed on the FlexRET output first.



Gender Adapter

The direction of mounting is also marked on the label of the Gender Adapter by an arrow showing to the chequered side plus the word “Antenna”. Afterwards, the AISG control cable of one BTS needs to be connected to the FlexRET input (marked with “in”) and the control cable of the other BTS needs to be connected to the Gender Adapter.

The allocation of the different antenna arrays is performed during the commissioning phase of the BTS setup. The first active BTS can address those arrays which shall be controlled via this BTS. The other BTS will then only see the remaining arrays which have not been addressed by the first BTS and can then address these remaining arrays.

At the input where the Gender Adapter is connected, the serial number of the FlexRET module is, in addition to the array ID, also extended by the character “G”. Example: CSG3415804**G**-Y1. The serial number of the FlexRET module at the original AISG input remains as before, e.g. CSG3415804-Y2.

### Connecting More Than Two BTS Using a Site Sharing Adapter

The installation of AISG antenna line devices in between the Site Sharing Adapter and the FlexRET antenna is not possible. If needed, they must be installed prior to the Site Sharing Adapter. The Site Sharing Adapter can be fixed at the mast with the included tension band. Attach the AISG cables of the different BTS to the AISG inputs of the Site Sharing Adapter. One control cable then needs to be connected from the AISG output of the Site Sharing Adapter (marked with “FlexRET”) to the AISG input of the FlexRET antenna. If an input of the Site Sharing Adapter remains unused, do not remove the protection cap. Dependent upon the site installation, the use of the optional grounding point of the Site Sharing Adapter may be necessary. Before deploying the Site Sharing Adapter, one initial configuration needs to be performed in order to allocate the corresponding bands to the respective BTS. A configuration file is created by specialised software which needs to be uploaded to the Site Sharing Adapter by an adequate primary. This can be realised directly with the Kathrein PCA or ALC or by an AISG software download via the BTS. This process is described in more detail in the manual of the Site Sharing Adapter or of the corresponding control device. The configuration software is available at [www.kathrein.com](http://www.kathrein.com). The allocation can also directly be performed using a Kathrein control device, i.e. PCA or ALC.

In addition to the array ID, the serial number of the FlexRET module is also extended by the corresponding input port character of the Site Sharing Adapter (“A” to “C” for 3-way, “A” to “F” for 6-way), e.g. by “A” for input “A”. Example: CSG3415804**A**-Y1.

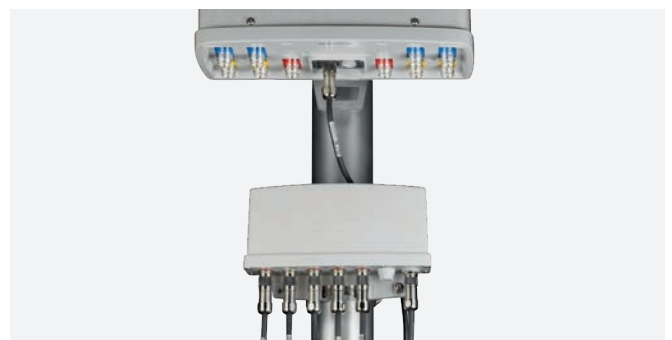

## > Daisy-chain Configuration

FlexRET antennas can also be used in a daisy-chain configuration. Remove the protection caps from the AISG input and output of the first antenna which are marked by the words “in” and “out”. Connect the control cable to the input. Remove the protection cap from the AISG input of the second FlexRET antenna and attach a control cable to interconnect the input with the output of the first antenna. Proceed like this for further antennas. Please note: do not remove the protection cap of the AISG output of the last FlexRET module. A combination with external RCUs in daisy chain is also possible. Please see the installation instructions for external RCUs for more details. The maximum number of antennas usable in daisy chain is dependent upon the primary, e.g. up to a total number of nine FlexRET antennas and/or external RCUs with the ALC.

### Daisy-chain Configuration Using a Site Sharing Adapter

If more than two BTS are connected to the FlexRET antenna via a Site Sharing Adapter, the maximum number of FlexRET antennas in daisy chain is limited to three. A combination with external RCUs is not possible in this case.

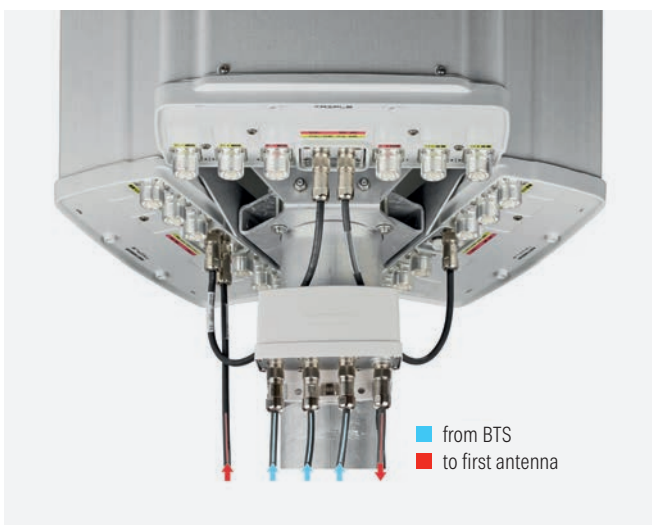

### Daisy-chain Configuration with Exactly Two BTS Using a Port Extender

If exactly two BTS are used and the allocated FlexRET antennas shall be used in a daisy-chain configuration, a Port Extender (type no. 86010163) is needed. If the Port Extender is used, the type number of the FlexRET module needs to be 86010153V01, compare “Connecting Two BTS Using a Gender Adapter” on page 12. The Port Extender is a device extending the one existing FlexRET input and output of the FlexRET antenna to two FlexRET inputs and outputs. Thus, exactly two BTS can share the input of the FlexRET antenna and can be daisy-chained to the next FlexRET antenna. The Port Extender is mounted on the existing FlexRET module by fixing it with two additional screws included in the scope of supply (type torx T-20).



The inputs of the Port Extender are marked pairwise, i.e. “in” and “out” respectively “G-in” and “G-out”. The serial number of the FlexRET module at input “G-in” is, in addition to the array ID, also extended by the character “G”, e.g. CSG3415804G-Y1. The serial number of the FlexRET module at the input “in” remains as before, e.g. CSG3415804-Y2. It is important to always use the same input/output port at all daisy-chained FlexRET antennas for the same BTS, e.g. all ports “in”/“out” for BTS 1 and all ports “G-in”/“G-out” for BTS 2.

## > Exchanging the FlexRET Module

The last FlexRET antenna in daisy chain should be used with a Gender Adapter instead of the Port Extender. The allocation of the different antennas and arrays is then performed like described in “Operation With Several BTS” on pages 12–13.



The FlexRET modules with connected Port Extender can also be daisy-chained with external RCUs. If the RCUs are daisy-chained behind a Port Extender, it is essential that the external RCUs are connected to the correct output of the Port Extender. If the RCUs shall be addressed by the BTS connected to input “in” of the Port Extender, they must be connected to output “out”. If the RCUs shall be addressed by the BTS connected to input “G-in” of the Port Extender, they must be connected to output “G-out”. If an output of the Port Extender remains unused, it should be terminated with the protection caps included in the scope of supply.

The number of controllable devices is not limited by the Port Extender. The maximum number of controllable devices depends on the BTS.

All FlexRET antennas are delivered with an integrated RET module. However, this module can be replaced if necessary. To exchange the module, the two screws (type Torx T-20) of the existing module need to be released first.

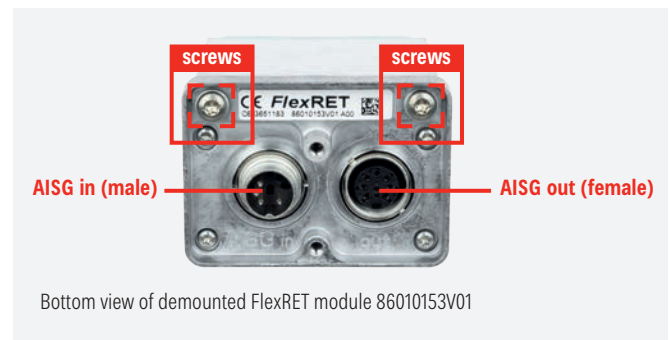

The module will then slide out until stopped by an internal mechanical stop, the module will not fall out by itself. The module can be released by pulling it further. The new module (type no. 86010153V01) can then be placed in the slot and the screws need to be tightened with a torque of 3 Nm.



The antenna information is stored on an internal RFID tag in the FlexRET antenna. The new FlexRET module receives antenna information stored in the antenna automatically after the power is switched on. It is not necessary to configure the FlexRET with antenna data manually. Again, only site-specific information needs to be added. Since the module is not yet calibrated, an initial calibration for each antenna system needs to be performed.

## Installation Guidelines – External RCU

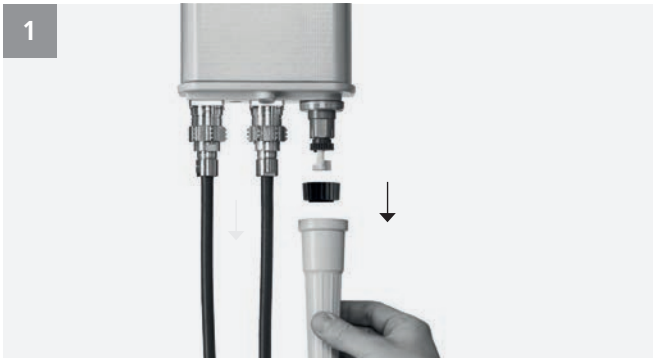

- Twist off the protective cap completely from the antenna
- Completely remove the black adjustment wheel by simply pulling it downwards
- Check the proper function of the phase shifter over the entire adjustment range by twisting the adjustment wheel in such a way that the spindle moves completely in and out. Reset the downtilt to minimum tilt



- Push the attachment nut of the RCU down towards the housing
- Place the RCU carefully over the adjustment spindle, observing the correct alignment of the RCU with regard to the antenna, i.e. the flat surfaces of the attachment fixture on the antenna side and those inside the RCU housing must lie flat against each other
- Push up the RCU carefully to the stop at the antenna



- Clean the thread surface. Apply the assembly paste evenly onto the full circumference of the thread as illustrated in the figure

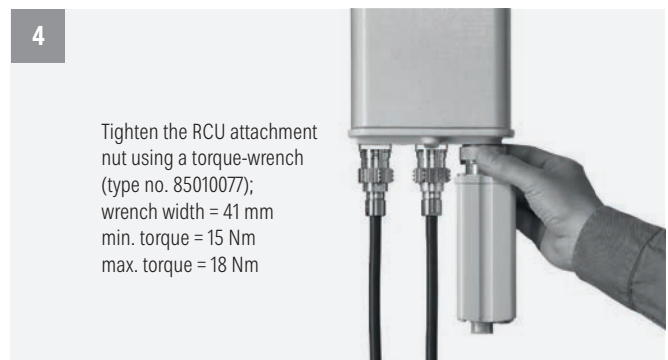

- Connect the RCU control cable immediately after attachment of the RCU. The tightening torque for fixing the control cable connector must be 1.0–1.5 Nm. This can be done by hand or by a special torque screwdriver (type no. 85010080)
- If the AISG output of the RCU remains unused, the protection cap shall not be removed



## > Daisy-chain Configuration



For a daisy-chain configuration, remove the protection cap and attach a control cable to interconnect with the daisy-chain input of the subsequent RCU.

### PLEASE NOTE!

Do not remove the protection cap from the daisy-chain output of the last RCU.

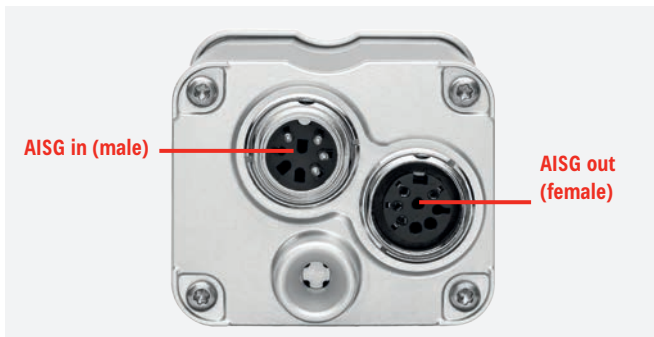

Bottom view of RCU

## > RFID Functionality



If the RCU and the antenna both have RFID functionality, the antenna details are automatically read out by the corresponding primary:

1. Antenna type number
2. Antenna serial number
3. Antenna configuration file

The serial number of the RCU is then extended by the according AISG colour coding ID of the connected antenna array, e.g. by "R1" if connected to a lowband array. Example: CSG3081908-**R1**

If the RCU 86010148V01 is used in combination with an antenna without a built-in RFID tag, the extension "-XX" is displayed instead of the array ID.

In case the RCU is manually addressed, the colour coding extension needs to be added to the serial number of the RCU as indicated.

### PLEASE NOTE!

To provide the RFID functionality, it is essential that the spindle is kept at minimum tilt before mounting the RCU.

## Questions and Answers – FlexRET and RFID-RCU

### > How do you commission FlexRET antennas?

When commissioning a FlexRET antenna, a corresponding control device, e.g. a base station (BTS) or a Kathrein PCA or ALC, also called “primary”, needs to be connected via an AISG cable. After scanning the FlexRET device, the following antenna information is automatically read out:

1. Antenna type number
2. Antenna serial number
3. Antenna configuration file

The installer only needs to add site-specific information like sector ID, installer ID, etc. An initial configuration process is not necessary since the FlexRET antennas are pre-configured and calibrated before leaving the factory.

### > What is the meaning of the colour coding?

According to AISG, the frequencies shall be marked with their respective colour coding abbreviation:

Frequency/ MHz Defined by AISG	Frequency Range/ MHz Examples	Colour	Colour Coding Abbreviation
380–1000	698–960 698–894 790–960	Red	R
1001–1700	1427–1518	Green	G
1701–2300	1710–1880 1710–2180 1920–2170 1350–2200	Blue	B
2301–4000	2490–2690 1695–2690 1427–2690 3300–3800	Yellow	Y

When using a FlexRET antenna, the serial number of the FlexRET module is extended by the corresponding array ID as stipulated by AISG. The array ID describes the corresponding frequency range by its colour coding abbreviation and an identification number. The identification number is a unique identifier for each antenna system, e.g. “Y3” for the third broadband high-band array.

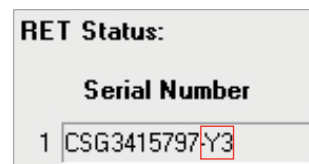

PCA: Serial number of the FlexRET module

The array ID is also marked on the HF ports of the antenna in order to ease the identification. All FlexRET antennas also show markings on the bottom plate indicating the position of the corresponding array.



### > Can I use the FlexRET in daisy chain?

Yes, it is possible to connect different FlexRET antennas via daisy chain. The maximum number of antennas usable in a daisy chain is dependent upon the primary device, e.g. up to nine FlexRET antennas with the ALC or up to 27 FlexRET antennas with the PCA.

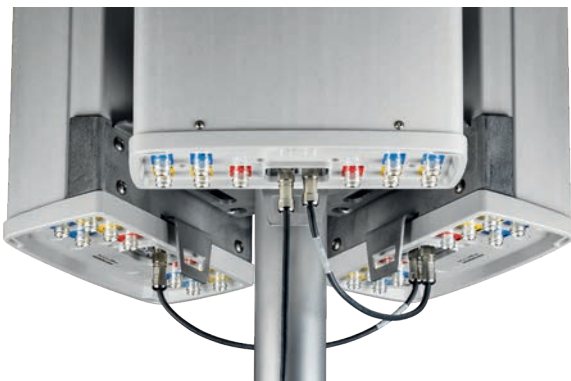

### > Can I use the FlexRET together with an external RCU?

Yes, a combination with external RCUs in daisy chain is possible. The maximum number of antennas usable in daisy chain is dependent upon the primary device, e.g. with the PCA up to a total number of 27 RET devices, i.e. FlexRET antennas, external RCUs or a combination of both.

### > What if I want to deploy site sharing with different BTS?

If the RET control of a FlexRET antenna cannot be handled via one single RET-signal path, the different RET signals need to be interconnected to the FlexRET input of the antenna. For this, two different possibilities exist: if exactly two BTS need to be connected to the FlexRET antenna, a Gender Adapter (type no. 86010162) can be used. If more than two BTS are connected, a Site Sharing Adapter is needed (type no. 86010154/55). With these Site Sharing Adapters, up to three respectively six different BTS or operators can be connected to one common FlexRET antenna input.



Site sharing realised with the 6-way Site Sharing Adapter

### > How is the Gender Adapter installed?

The Gender Adapter can easily be screwed on the AISG output of FlexRET module (type no. 86010153V01). For this, the chequered side of the Gender Adapter needs to be screwed on the FlexRET output. This has to be done prior to the installation of the AISG cables. The direction of mounting is also marked on the label of the Gender Adapter by an arrow showing to the chequered side plus the word "Antenna".



Gender Adapter

### > How are the antenna arrays allocated with the Gender Adapter?

The allocation of the different antenna arrays is performed during the commissioning phase of the BTS setup. The first active BTS can address those arrays which shall be controlled via this BTS. The other BTS will then only see the remaining arrays which have not been addressed by the first BTS and can then address these remaining arrays. Since the addressing cannot be performed by two BTS simultaneously, it is recommended to handle the commissioning consecutively.

### > How is the serial number of the FlexRET module extended when using a Gender Adapter?

At the input where the Gender Adapter is connected, the serial number of the FlexRET module is, in addition to the array ID, also extended by the character "G" (example: CSG3415804**G**-Y1).

The serial number of the FlexRET module at the original AISG input remains as before, e.g. CSG3415804-Y2.

### > How is daisy-chaining realised with exactly two BTS?

If exactly two BTS are used and the allocated FlexRET antennas shall be used in daisy-chain configuration, a Port Extender (type no. 86010163) is needed. This Port Extender is a device extending the one existing FlexRET input and output of the FlexRET antenna to two FlexRET inputs and outputs. Thus, exactly two BTS can share the input of the FlexRET antenna and can be daisy-chained to the next FlexRET antenna. The last FlexRET antenna in daisy chain should be used with a Gender Adapter instead of the Port Extender.

The inputs of the Port Extender are marked pairwise, i.e. "in" and "out" respectively "G-in" and "G-out". It is important to always use the same input/output port at all daisy-chained FlexRET antennas for the same BTS, e.g. all ports "in"/"out" for BTS 1 and all ports "G-in"/"G-out" for BTS 2.



### > Can the Port Extender be combined with external RCUs?

The FlexRET modules with connected Port Extender can also be daisy-chained with external RCUs. If the RCUs are daisy-chained behind a Port Extender, it is essential that the external RCUs are connected to the correct output of the Port Extender. If the RCUs shall be addressed by the BTS connected to input "in" of the Port Extender, they must be connected to output "out". If the RCUs shall be addressed by the BTS connected to input "G-in" of the Port Extender, they must be connected to output "G-out". If an output of the Port Extender remains unused, it should be terminated with the protection caps included in the scope of supply.

### > How is the serial number of the FlexRET module extended when using a Port Extender?

The serial number of the FlexRET module at input "G-in" is, in addition to the array ID, also extended by the character "G", e.g. CSG3415804**G**-Y1. The serial number of the FlexRET module at the input "in" remains as before, e.g. CSG3415804-Y2

### > How many FlexRET antennas/external RCUs can be controlled when using a Port Extender?

The number of controllable devices is not limited by the Port Extender. The maximum number of controllable devices depends on the BTS.

### > Which FlexRET antennas can be used with the Gender Adapter or Port Extender?

If the Gender Adapter or Port Extender is used, the type number of the FlexRET module needs to be 86010153V01. The type number can be found on the outer label of the FlexRET module. If the type number version is lower, the FlexRET module needs to be exchanged beforehand.



FlexRET module  
86010153

FlexRET module  
86010153V01

### > How are the antenna arrays allocated with the Site Sharing Adapter?

Before deploying the Site Sharing Adapter, one initial configuration needs to be performed in order to allocate the corresponding bands to the respective BTS. With special software, a configuration file is created on a computer, which needs to be uploaded to the Site Sharing Adapter by an adequate primary via a standard AISG software download. This procedure can also be performed by the BTS or any arbitrary AISG control device.

A second possibility is to use Kathrein control devices. The PCA can be used in combination with the Site Sharing Configuration Software to directly upload the configuration to the connected Site Sharing Adapter and FlexRET antennas. A detailed manual for the configuration of the Site Sharing Adapter is available on our website. The software is also available for download. After the assignment, each BTS can be independent from the others without seeing or influencing the tilt settings and signals of the other BTS. With the ALC, a direct configuration of the Site Sharing Adapter is possible via the ALC menu.

For both possibilities, the set configuration can be secured by a password protection.

### > How is the serial number of the FlexRET module extended when using a Site Sharing Adapter?

In addition to the array ID, the serial number of the FlexRET module is also extended by the corresponding input port character of the Site Sharing Adapter ("A" to "C" for 3-way, "A" to "F" for 6-way), e.g. by "A" for input "A". Example: CSG3415804**A**-Y1

### > How many antennas can be controlled with one Site Sharing Adapter?

Up to three FlexRET antennas in daisy-chain configuration can be controlled with one Site Sharing Adapter. This means that the Site Sharing Adapter can in total handle up to three different FlexRET antennas with up to three or six different BTS, dependent upon the used type 86010154 or -155.

Please note: a combination of FlexRET and antennas with external RCUs is not possible with the Site Sharing Adapter.

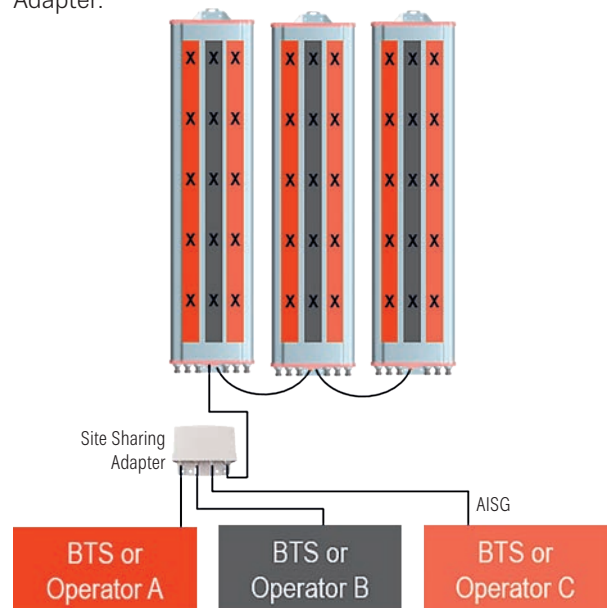

### > Can the Gender Adapter and the Site Sharing Adapter be combined?

A combination of the Gender Adapter or the Port Extender with the Site Sharing Adapter is not possible.

### > Can the FlexRET module be replaced?

All FlexRET antennas are delivered with an integrated RET module. However, this module can be replaced if necessary.



The antenna information is stored on an internal RFID tag in the FlexRET antenna. The new FlexRET module receives the antenna information stored in the antenna automatically after the power is switched on. It is not necessary to configure the FlexRET with antenna data manually. Again, only site-specific information needs to be added.

Since the module is not yet calibrated, an initial calibration for each antenna system needs to be performed. More information about this is given in the manual of the respective Kathrein control devices.

### > Which possibilities exist for the communication between the FlexRET antenna and the primary?

3GPP defines two different types of devices for the RET control: single or multi-antenna devices. All FlexRET antennas support both types of communication, called "RET modes". They are differentiated into the SingleRET mode (single-antenna device) and the MultiRET mode (multi-antenna device). The default mode ex-factory is the SingleRET mode.

The mode required depends on the mode used by the deployed base station. Any queries related to the mode of operation of the base station should be directed to the corresponding base station supplier. The RET mode can be changed if the FlexRET receives the corresponding command from a primary device.

All FlexRET antennas can also be used with AISG 1.1.

> **How can the RET mode be switched?**

To switch between the modes, type the vendor specific command into the field "Installer ID" and perform a subsequent rescan:

- SingleRET Mode: Command "3GPPS"
- MultiRET Mode: Command "3GPPM"

Serial Number	Vendor	TYPE	Sector ID	Antenna Type	Inst. Date	Installer ID	Basestation ID
1 CSG3415804	KA	MultiRET	1	86010148V01	101213	3GPPS	
			2	86010148V01			
			3	86010148V01			
			4	86010148V01			
			5	86010148V01			

PCA: Menu "Wizard Setup"

For Kathrein's ALC and PCA, the mode switch can be performed via a drop down menu.

In MultiRET mode, the serial number is in opposition to the SingleRET mode extended by the abbreviation "MM" as stipulated in AISG.

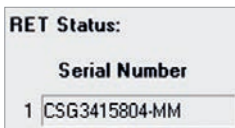

PCA: Menu "Device Status"

The selected mode of communication has no impact on the physical operation of the antenna. It only defines how the communication between the primary and the FlexRET antenna is conducted.

A more detailed explanation about the mode switches is given in the corresponding manuals of the respective Kathrein control devices.

> **Is it also possible to have automatic antenna configuration for antennas without the FlexRET functionality?**

A further innovative solution for all existing antennas with external RCUs is provided by Kathrein: the RCU with RFID feature, providing RFID-based communication between the antenna and the RCU.

> **How does the RCU with RFID feature work?**

The upgraded RCU, type no. 86010148V01, is equipped with an internal RFID reader. In addition, our antennas have successively been equipped with the corresponding RFID tags. All relevant antenna data is stored on this tag, namely

1. Antenna type number
2. Antenna serial number
3. Antenna configuration file

Once the power is switched on, the antenna details are automatically read out by the corresponding primary. Again, only site-specific information needs to be added. To provide the RFID functionality, it is essential that the spindle is kept at minimum tilt before mounting the RCU.





## > How is the calibration carried out?

Using the RFID-RCU in combination with an RFID spindle, the calibration is automatically carried out when setting the first tilt value. Hence, no additional calibration is necessary in this case.

## > Does the RCU 86010148V01 also provide colour coding information?

If this RCU is used together with an antenna which already has the RFID tag built in, then the colour coding array ID will be included as an extension of the serial number.

RET Status:	
Serial Number	Sector ID
1 CSG3081908R1	...

PCA: Menu "Device Status"

If the new RCU is used in combination with an antenna without a built-in RFID tag, the extension "-XX" is displayed instead of the colour coding.

## > Can the RCU 86010148V01 be used for antennas without RFID spindle?

Any mixed situation of old/new types is permissible. In these cases, no automatic configuration will be performed.

RCU	Antenna	RET control	Automatic configuration
86010148V01	with tag	✓	✓
86010148	with tag	✓	-
86010148V01	without tag	✓	-

## > How can I tell whether my antenna has spindles with RFID tags?

All antennas with RFID are clearly marked. One marking can be found on the antenna label showing the following symbol:



In addition, the packaging is also marked with the same logo. An up-to-date list of all antennas with RFID spindle is provided at [www.kathrein.com](http://www.kathrein.com)













### PLEASE NOTE!

Please note: all shown primary screenshots in this document are exemplarily demonstrated with the Kathrein PCA. Dependent upon the used primary and software version, the illustration may vary.

## DTMA's

Kathrein DTMA's are designed in a compact line and as double units for easy use with XPol antennas. All DTMA's have a bypass mode to ensure cell operation in case of DC power down and have a built-in lightning protection.

DTMA's with AISG compatibility support AISG 1.1 and AISG 2.0 (default) and are suitable for antenna RET control according to AISG/3GPP standard.

▶ ▶ ▶ DTMA			
 <p><b>700 MHz Band</b> 12 dB AISG/CWA</p>	 <p><b>800 MHz Band</b> 12 dB AISG</p>	 <p><b>900 MHz Band</b> 12 dB AISG/CWA</p>	 <p><b>AWS Band 1700/2100 MHz</b> 12 dB AISG/CWA</p>
▶ ▶ ▶			
 <p><b>1800 MHz Band</b> 12 dB AISG/CWA</p>	 <p><b>2100 MHz Band</b> 12 dB AISG/CWA</p>	 <p><b>2100 MHz Band</b> 12 dB AISG/CWA BYP 1800</p>	 <p><b>2600 MHz Band</b> 12 dB AISG</p>
▶ ▶ ▶ Dual-Band DTMA			System Components
 <p><b>800 &amp; 900 MHz Band</b> 12 dB AISG/CWA</p>	 <p><b>1800 &amp; 2100 MHz Band</b> 12 dB AISG</p>	 <p><b>1800 &amp; 2600 MHz Band</b> 12 dB AISG</p>	 <p><b>DC Stop</b> 250–3800 MHz</p>  <p><b>Smart Bias Tee</b> 690–2700 MHz</p>

Kathrein offers a large variety of different DTMA types with numerous features. The customer can choose an appropriate DTMA according to the following characteristics:

#### 1. ALARM MODES

- Single mode (AISG **or** CWA)
- Dual mode (AISG **and** CWA)

#### 2. VARIOUS FREQUENCY RANGES

- 700 MHz
- 800 MHz
- 900 MHz
- 1800 MHz
- 1900 MHz
- AWS
- 2100 MHz
- 2600 MHz

#### 3. DUAL-BAND DTMA'S FOR DIFFERENT FREQUENCY COMBINATIONS

- 800 MHz + 900 MHz
- 1800 MHz + 2100 MHz
- 1800 MHz + 2600 MHz
- AWS4 + ePCS

#### 4. DTMA'S WITH INTEGRATED COMBINER FUNCTIONALITY

- Two inputs, four outputs
- Splitting up combined signals at the antenna

#### 5. RF-BYPASS AT DIFFERENT FREQUENCIES

For an up-to-date overview of all existing types, please visit our website: [www.kathrein.com](http://www.kathrein.com)



Manuals and regular software updates for Kathrein RET products are provided via our customer portal. Please visit [www.kathrein.com](http://www.kathrein.com)

KATHREIN-Werke KG  
Anton-Kathrein-Straße 1-3  
83022 Rosenheim, Germany  
Phone +49 8031 184-0  
[www.kathrein.com](http://www.kathrein.com) | [mobilcom@kathrein.de](mailto:mobilcom@kathrein.de)

**KATHREIN**